

Filler SMALL-IN-ONE

24 filling valves



Proven technology designed for the small craft business, built on the ALL-IN-ONE platform.

Main features

- Glass bottles or cans can be handled in the same machine
- Tool free changeover in 20 minutes by 2 operators
- No compromises in quality

Simplified installation & maintenance

- Drive and gear transmission
- Compact design
- Shipped as one block on a single truck / HiCube container
- Ready for use 2 weeks after start of installation

Applications

- Beer
- RTD's
- Soft drinks (still & sparkling)
- Wine (still & sparkling)
- Water (still & sparkling)
- Juices (including fruit pulp, up to 1x6mm)

Filling temperature range

- 32° - 68°F

CO₂ content

- 0 - 8 gr/l

Formats

Cans

- Standard
- Sleek
- Slim

Glass bottles

- Diameter 50 - 90 mm
- Crown corks

Options

- ROPP / Aluminium screw cap
- Plastic screw cap

Configuration for crown corks and lids

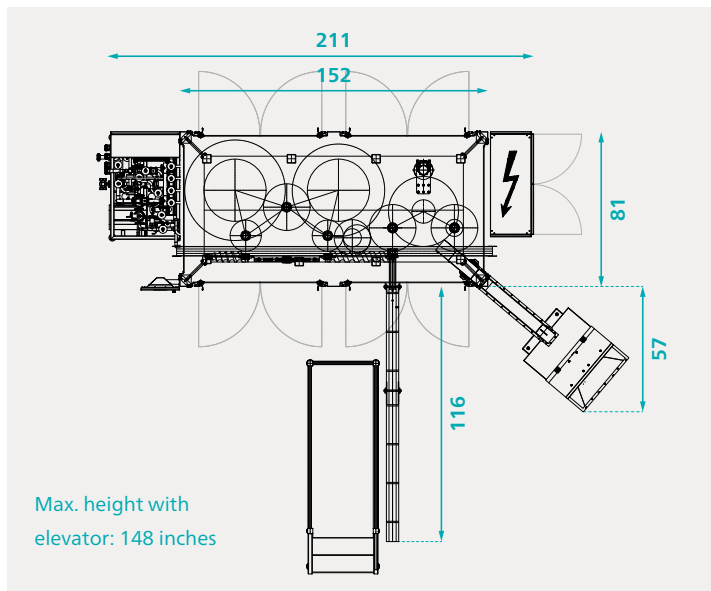

Configuration for crown corks and lids, ROPP caps

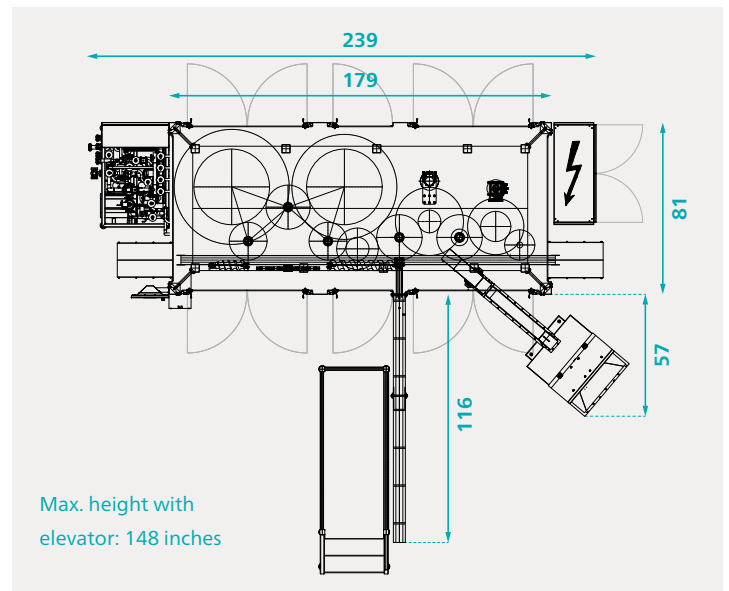

Capacities

Product	Filling temp. (°F)	CO ₂ content (g/L)	Filler nominal capacity (cpm)	Container volume (oz)
Beer	39	5,5	125	12
(Pils, Lager)			100	16
Beer	59	5,5	100	12
(Pils, Lager)			80	16
Soft drinks	39	5,5	110	12
/ RTD			90	16
Soft drinks	59	5,5	100	12
/ RTD			80	16
Carbonated water	59-68	6,5	130	12
			100	16
Still water	68-77	0	130	12
			130	16
Still wine	68	2	80	8.4
			50	25.3
Sparkling wine	39-42	8	60	8.4
			30	25.3
Juice	194	0	80	8.4
			35	33.8

Options and upgrades

- External flushing system with piping and nozzles for external cleaning
- Foaming system
- Platform for manual lid feeding
- Cap elevator
- Second capping turret complete with:
 - capping heads for ROPP cap
 - free places for future upgrade with plastic caps (can also be added after the machine is already installed)
- System for Hot-fill
- Simple cover with HEPA Filter

Basic scope

Item	Size 24
Orientation possible	L → R and R → L
Technical designation	VKR-E 24-24-4D/4K
Nr. of rinsing stations	24 universal grippers
Rinser Execution	2-channel rinsing (rinsing with disinfection + sterile water); pump not included
Nr. of filling valves	24
Filling system	Short vent tubes
Closing turret	Combination of: <ul style="list-style-type: none"> Crown cork - 1 cap type/size Seamer - 1 lid size/type
Nr. of capping heads	4
Nr. of seaming stations	4
Lid supply	Chute for manual loading (chute on 2,1 m height)
Software	B&R PLC & Control
Electrical specs	<ul style="list-style-type: none"> UL components UL certification
Accessories for filling beer	<ul style="list-style-type: none"> Vacuum pump Hot water injection Undercover gassing & bubble breaker
Format parts	<ul style="list-style-type: none"> 1 glass bottle with 1 type of crown cork 1 can type with 1 type of lid
Other	<ul style="list-style-type: none"> Bottle / can shower Water recirculation system from rinser to the bottle / can shower and vacuum pump