

Filler SMALL-IN-CAN

32 filling valves



Proven technology designed for the small craft business, built on the ALL-IN-ONE platform.

Main features

- Different cans & lids can be handled on the same machine
- Tool free changeover in 10 minutes by 2 operators (same lid)
- No compromises in quality

Simplified installation & maintenance

- Drive and gear transmission
- Compact design
- Shipped as one block on a single truck / HiCube container
- Ready for use 2 weeks after start of installation

Applications

- Beer
- RTD's
- Soft drinks (still & sparkling)
- Wine (still & sparkling)
- Water (still & sparkling)
- Juices (including fruit pulp, up to 1x6mm)

Filling temperature range

- 32° - 68°F

CO₂ content

- 0 - 8 gr/l

Formats

Cans

- Standard
- Sleek
- Slim

Configuration without rotary rinser

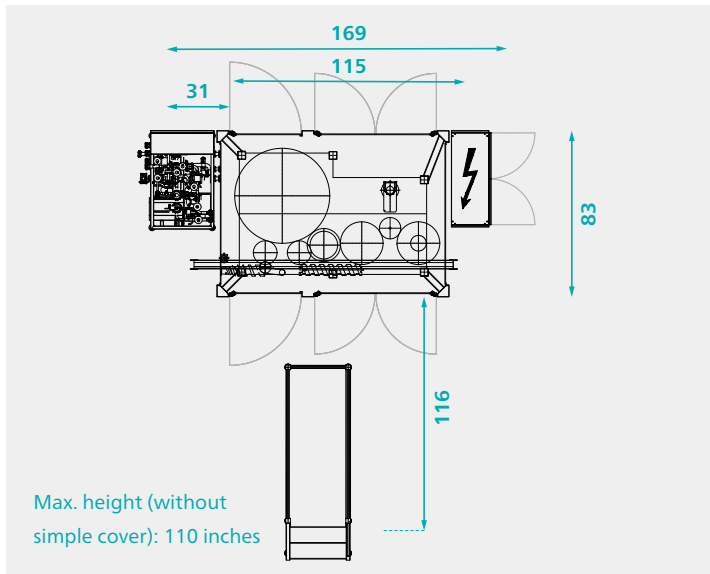

Configuration with rotary rinser

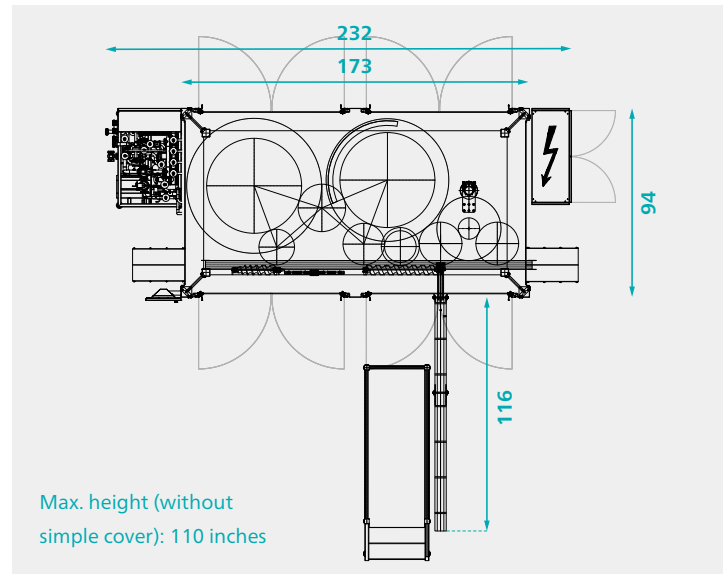

Capacities

Product	Filling temp. (°F)	CO ₂ content (g/L)	Filler nominal capacity (cpm)	Container volume (oz)
Beer	39	5,5	300	12
(Pils, Lager)			250	16
Beer	59	5,5	250	12
(Pils, Lager)			210	16
Soft drinks	39	5,5	280	12
/ RTD			240	16
Soft drinks	59	5,5	240	12
/ RTD			205	16
Carbonated water	59-68	6,5	300	12
			250	16
Still water	68-77	0	300	12
			300	16
Still wine	68	2	300	12
			250	16
Sparkling wine	39-42	8	240	12
			205	16
Juice	194	0	300	12
			300	16

Options

- 2 channel rotary rinser with universal grippers (rinsing with disinfection + sterile water) and water recirculation
- External flushing system with piping and nozzles for external cleaning
- Foaming system
- Platform for manual lid feeding
- System for Hot-fill
- Simple cover with HEPA Filter

Basic scope

Item	Size 32
Orientation possible	L → R and R → L
Technical designation	VKR-EID-DN 32-6D
Nr. of filling valves	32
Filling system	Volumetric
Closing turret	• Seamer - 1 lid size/type
Nr. of seaming stations	6
Lid supply	Chute for manual loading (chute on 2,1 m height)
Software	B&R PLC & Control
Electrical specs	• UL components • UL certification
Accessories for filling beer	• Vacuum pump • Undercover gassing & bubble breaker
Format parts	• 1 can type with 1 type of lid
Other	• Can shower at exit