

Filler SMALL-IN-CAN

16 filling valves



Proven technology designed for the small craft business, built on the ALL-IN-ONE platform.

Main features

- Different cans & lids can be handled on the same machine
- Tool free changeover in 10 minutes by 2 operators (same lid)
- No compromises in quality

Simplified installation & maintenance

- Drive and gear transmission
- Compact design
- Shipped as one block on a single truck / HiCube container
- Ready for use 2 weeks after start of installation

Applications

- Beer
- RTD's
- Soft drinks (still & sparkling)
- Wine (still & sparkling)
- Water (still & sparkling)
- Juices (including fruit pulp, up to 1x6mm)

Filling temperature range

- 32° - 68°F

CO₂ content

- 0 - 8 gr/l

Formats

Cans

- Standard
- Sleek
- Slim

Configuration without rotary rinser

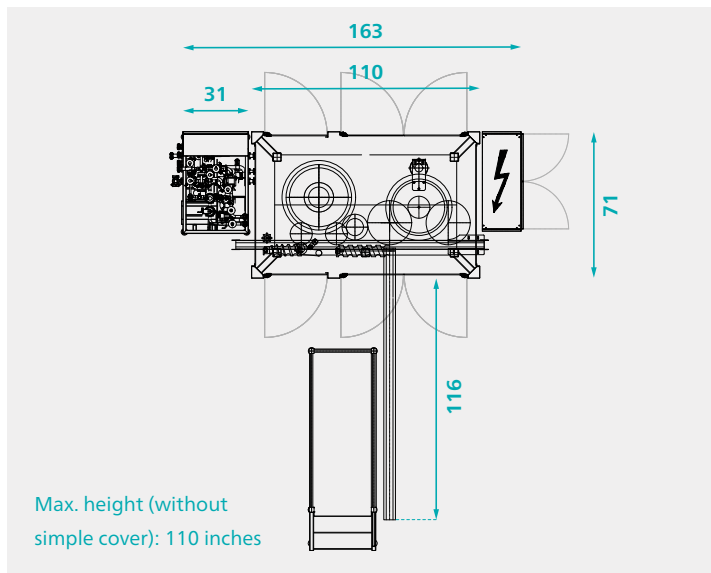

Configuration with rotary rinser

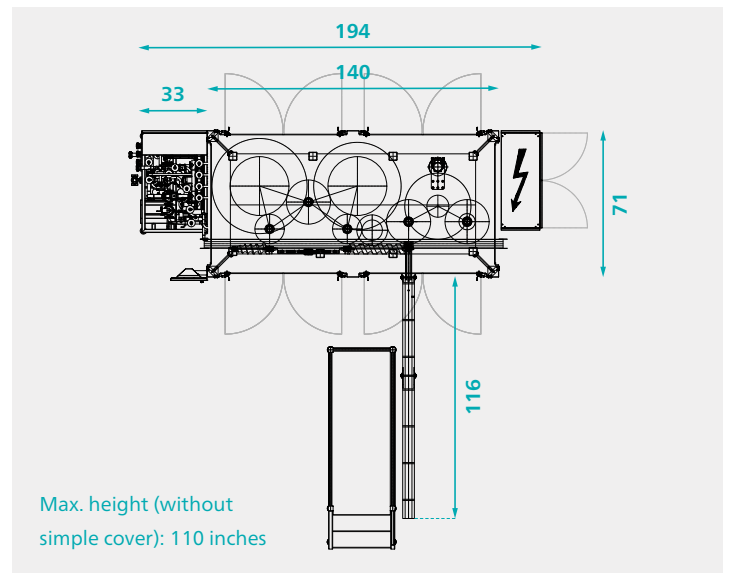

Capacities

Product	Filling temp. (°F)	CO ₂ content (g/L)	Filler nominal capacity (cpm)	Container volume (oz)
Beer	39	5,5	150	12
(Pils, Lager)			125	16
Beer	59	5,5	125	12
(Pils, Lager)			105	16
Soft drinks	39	5,5	140	12
/ RTD			110	16
Soft drinks	59	5,5	110	12
/ RTD			100	16
Carbonated water	59-68	6,5	150	12
			125	16
Still water	68-77	0	160	12
			160	16
Still wine	68	2	150	12
			125	16
Sparkling wine	39-42	8	115	12
			110	16
Juice	194	0	160	12
			150	16

Options

- 2 channel rotary rinser with universal grippers (rinsing with disinfection + sterile water) and water recirculation
- External flushing system with piping and nozzles for external cleaning
- Foaming system
- Platform for manual lid feeding
- System for Hot-fill
- Simple cover with HEPA Filter

Basic scope

Item	Size 16
Orientation possible	L → R and R → L
Technical designation	VKR-EID-DN 16-4D
Nr. of filling valves	16
Filling system	Volumetric
Closing turret	• Seamer - 1 lid size/type
Nr. of seaming stations	4
Lid supply	Chute for manual loading (chute on 2,1 m height)
Software	B&R PLC & Control
Electrical specs	• UL components • UL certification
Accessories for filling beer	• Vacuum pump • Undercover gassing & bubble breaker
Format parts	• 1 can type with 1 type of lid
Other	• Can shower at exit